



# INTERNATIONAL WOOL TEXTILE ORGANISATION

**TECHNOLOGY & STANDARDS COMMITTEE**

**BARCELONA MEETING**

**Sliver Group**

**May 2002**

**Chairman: J. TURK (Australia)**

**Report No: SG 02**

---

Introducing OFDA4000: A New Instrument for Simultaneous Measurement of Fibre Length and Diameter in Tops

By

Mark Brims

---

BSC Electronics Pty Ltd.

[www.ofda.com](http://www.ofda.com)

---

## **BRIEFING PAPER**

### **SUMMARY OF FINDINGS**

OFDA4000 is a new instrument that measures length, hauteur, diameter, diameter profile and curvature in tops using a digital video microscope. It inherits over 10 years of experience with the OFDA100 and OFDA2000, and uses a new, much smaller and simpler integrated fibre aligner than the Fibroliner used by the Almeter.

The operation of the new OFDA4000 is described, and preliminary measurements of length, hauteur and diameter profile on wool tops are presented. For the first time, diameter profile along the top beard can be measured automatically, and the implications of this on the difference between hauteur and length are introduced.

### **COMMERCIAL IMPLICATIONS – CURRENT AND FUTURE**

Currently this report has no commercial implications. The preliminary data will be used as a basis for setting up a working group and round trials to establish an IWTO Draft Test Method for this instrument.

In the future, it is envisaged that the extra information provided by the OFDA4000 will be useful for predicting comfort factor and spinning performance. Some anomalies in prediction from the TEAM equation may be explained by the extra measurements. Compatibility with OFDA2000 greasy wool profile measurement provides the possibility of targeting particular farm lots for producing specialised wool products. Reducing the manual handling, labour time and the number of instruments and computers in the laboratory will lead to efficiency gains.

### **NOTE**

This report will be presented at the IWTO Congress in Barcelona, in the Sliver Group Meeting at 14:30 on 24th May 2002.

**INTERNATIONAL WOOL TEXTILE ORGANISATION****TECHNOLOGY & STANDARDS COMMITTEE****BARCELONA MEETING**

Sliver Group

May 2002

Chairman: J. TURK (Australia)

Report No: SG 02

---

Introducing OFDA4000: A New Instrument for Simultaneous Measurement of Fibre Length and Diameter in Tops

By

Mark Brims

---

BSC Electronics Pty Ltd.

[www.ofda.com](http://www.ofda.com)

---

## **SUMMARY**

The OFDA4000 is a new instrument developed to provide simultaneous measurement of fibre length, hauteur, diameter, diameter profile and curvature from tops. A digital video microscope measures all these parameters. OFDA4000 represents the first fully automatic measurement of fibre length (as distinct from hauteur) and is combined with the proven diameter measurement of the OFDA100 and diameter profile measurement of the OFDA2000. Extra information regarding length and profile will be useful to help processors predict the fibre end comfort factor and spinning performance. Furthermore, the possibility exists for OFDA2000 on farm profile measurement to be tracked through to the resulting tops.

## **HISTORY**

The OFDA100 was developed in 1990 [1] to measure fibre diameter on 2mm long snippets of wool scattered on a 70mm\*70mm glass slides. The ability to measure fibre curvature [2] and medullation [3] was added later, and the OFDA100 received two IWTO test methods, IWTO-47[4] and IWTO-57[5]. The ability to reliably and quickly measure all these parameters by digital video proved popular and the instrument became a worldwide market leader, with over 165 instruments in use.

It was realised that the ability to quickly measure diameter on-farm would be useful for woolgrowers to improve their flocks, and so the OFDA2000 was developed in 1999[6]. The OFDA2000 used identical image processing algorithms to the OFDA100, but this software was migrated from 16 bit dos code to 32 bit Windows code, and the hardware moved from the ISA bus to the much faster PCI bus. This resulted in a speed increase of over 20 times, but the speed was then limited by the video camera at 50 images per second.

The OFDA2000 is a portable instrument, and is the first instrument to measure greasy wool diameter. It also added the capability to measure diameter profile along the staple. Along staple profile is an

important measure of the history of the sheep since the last shearing and is related to wool strength and comfort factor (for a list of over 15 papers on OFDA2000 profile work see [7]). Profile is being accepted as a useful tool by leading growers. Extreme profiles have been found along a single year wool growth with a range from 17um to 30um. Since weight is proportional to the square of diameter, the weight per cm at one end of the fibre is 3 times that at the other end. The OFDA2000 has proven successful in the marketplace with over 85 in use. Processing-prediction tools are being developed to allow prediction of hauteur at the sale-lot level from the OFDA2000 profiles[8].

In 2000, it was realised that the OFDA2000 technology could be applied to tops to measure length and diameter, providing a suitable beard preparation device could be constructed. A prototype beard preparation fibre aligner was built and attached to a standard OFDA2000 arm and the instrument was named OFDA4000. The first in-house testing of the prototype took place at the end of 2001, and the results were very encouraging. Currently, three improved beta prototypes are being constructed with anticipated completion by June 2002.

### **Why Develop OFDA4000?**

The primary reason for developing OFDA4000 was to combine the measurement of diameter and length into one instrument. Customer concern about the reliability, maintenance cost and continued supply of the existing measurement technology was also a major factor. When the prototype was developed, it was realised that there were many advantages over the existing technologies of length and diameter measurement.

These include:

1. Measure length, diameter and curvature precisely by digital video.
2. New measurements of diameter profile and beard end comfort factor
3. Operator involvement 1 minute to do a full measurement of all parameters
4. No manual handling of beards
5. No snippet handling required as in OFDA100 or Laserscan
6. Data held in one file on one computer, no extra programs required to combine data
7. Size and weight less than 1/3 of OFDA100/Almeter/Fibroliner combination.
8. Windows based graphical interface, internet connection, and remote control via phone for support.
9. Designed to allow robotic loading of tops
10. Possible platform for addition of extra measurements, such as neps, VM, dark fibre, strength, medullation.

### **Wool Fibre Length and Hauteur**

The history of wool fibre length measurement is beyond the scope this paper. Wool fibre length is not an exactly defined term, since it can vary from the relaxed length to the fully stretched length. Attempts to manually measure the fully stretched length can be hampered by the tendency of fine fibres to break. One instrument that measures individual fibre length in a stretched state under a nominally standardised tension is the WIRA single fibre length machine (IWTO DTM5). This instrument is impractical for all but research work on fibres recovered from yarns or fabrics. The WIRA fibre diagram (IWTO-16) is a semi-automated instrument that also measures fibre length distribution after the fibres have been prepared in

a semi-tensioned state. However, the most common instrument now used for fibre length distribution measurement is the Almeter (IWTO-17).

Developed in the 1960s and 1970s, the Almeter uses a machine called a Fibroliner to prepare beards of end aligned fibres which are then carefully laid between plastic sheets to be inserted into the Almeter. These beards contain fibres in a semi-relaxed state, which is simply defined by the output of the Fibroliner and inserted immediately into the Almeter. This semi-relaxed state is influenced by the history of the top and probably the fibre curvature.

The Almeter scans the beard with a capacitance sensor to measure the quantity of wool at each point along the beard. This measurement is proportional to the number of fibres multiplied by the cross sectional area of each fibre at that point. This cross section biased length is called Hauteur[11][12]. If the diameter of the fibres does not alter along the beard, then the Hauteur will be the same as fibre length. The Almeter does not measure fibre length.

A change in fibre diameter profile along the beard will cause the Hauteur to be different from the fibre length. Since this is based on the cross sectional area, the difference is proportional to the square of diameter. For example, if the diameter has a 5% increase from 20um to 21um along the beard, the increase in the cross sectional area will be  $(21/20)^2$  or 10.2%.

The OFDA4000 measures length by counting the number of fibres across the beard at 5mm steps. It is recognised that this length may be known as "OFDA4000 length", but for readability, the term length or OFDA4 length will be used throughout the rest of this paper. The hauteur is calculated from multiplying this length by the square of the diameter profile, and the barbe is calculated from the length distribution in a similar way to the Almeter, although the Almeter barbe will be different since it is based on hauteur and not length. The OFDA4000 provides the length based barbe and the hauteur based barbe to compare with Almeter barbe.

Summarizing the length values from OFDA4000:

- Length: the length of each fibre in the beard at 5mm resolution
- Hauteur: the cross section biased length obtained by multiplying length by the square of the diameter at each 5mm measurement scan
- Barbe: the weight biased distribution, which is the percentage of fibres by weight that exceeds each length
- Almeter barbe: the weight biased distribution, which is the percentage of fibres by weight that exceeds each hauteur length

It is well known that top beards can have a diameter profile, and a draft test method currently before IWTO [13] for measuring the diameter at the end of the beard is testament to this. There are 3 ways that a beard can have a diameter profile:

1. Wool used to blend for the top has a profile, such as wool sourced at the same time of year from sheep running in conditions of seasonal feed variation.
2. Fibres are selectively broken during the top making process, for example: if the fine fibres break then the diameter will increase along the beard.
3. Wool is blended from different sources, for example: short fine wool blended with broader longer wool would create an increasing diameter profile along the beard.

**OFDA4000 Hardware**

Figure 1: OFDA4000 CAD Isometric View

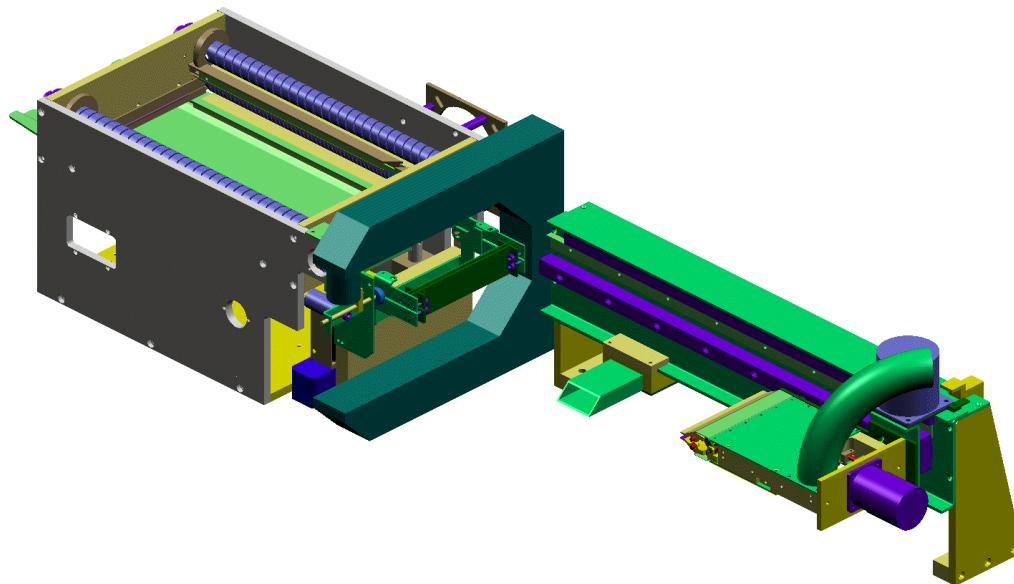
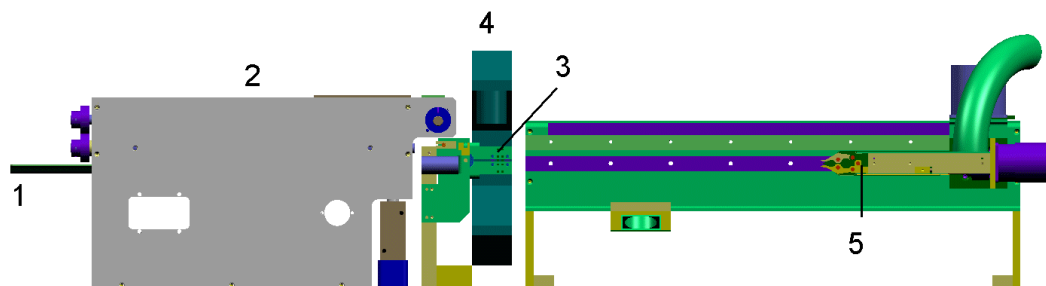

Figure 2: OFDA4000 CAD Side View



The OFDA4000 hardware consists of an input feeding shute (1), a moving needle bed to align and hold the fibres (2), a beard guide (3), a transverse video microscope arm (4) and a moving gripper (5). The full length of the prototype is 1.05m.

The needle bed is different to that used in the Fibroliner in that the needles are introduced row by row into the top, rather than pushing the entire top into the bed. The combination of a needle bed that can be fed in steps from 0.1mm to 30mm with a gripper that can be positioned in a range of 30mm from the end of the needle bed with 0.1mm accuracy allows a very wide control over fibre density. Beards of density from less than 100 fibres to the full number of fibres across the top can be extracted. The full top can be fed through the needle bed without any combing action at all by extracting it at the same speed as the needle bed is feeding it, and this is used to clear out the needle bed after a measurement.

Reliability and ease of maintenance were identified as major customer concern, and hence the design allows single needle row to be replaced in less than 20 seconds.

The drawn fibre beard is held in the microscope focal plane by the beard guide, which is set to a gap size of 0.2mm to prevent holding the fibres so tightly that they break, and to allow neps to pass through. The state of the fibres when their length is measured is semi stretched. At the point that the end of the fibre passes through the guide and stops being counted, the fibre will have shrunk slightly from the almost fully stretched state it was in as it left the beard.

The first scan across the beard is not at the start of the beard (0mm) since this is held in the gripper. The position of the first scan to the end of the beard is set by the width of the fibre guide, the distance from the guide to the tip of the gripper and the length of fibres inside the gripper. In theory, the end of the beard will never be perfectly aligned, but will at best be aligned in a range equal to the needle bed protrusion step size. This size can be varied to achieve the correct beard density, and is typically 1.5mm. Hence at best the fibres are aligned to +/- 0.75mm of the "true" end of the beard, where the true end of the beard is defined as the mid pint of the feed step. The computer automatically adds this length since it has determined the step size. With the current prototype, the first measurement takes place 6.8mm from the end of the beard. The next prototype is being constructed to reduce the position of this first measurement to less than 5mm from the beard end.

#### Sequence of Operation

1. A top is fed into the input chute and the sample identification is entered on the computer.
2. The needle bed begins moving and pulls the top in
3. A sensor detects when the beginning of the top has reached the extraction point at the exit end of the needle bed.
4. The fibre gripper moves to the extraction point with its jaws open and closes onto the protruding fibres.
5. The gripper pulls back to the vacuum point and removes a predraw beard, which is then vacuumed away. The needle bed feeds forward to present another set of fibre ends.
6. The predraw actions repeat until the set predraw length has been reached.
7. The measurement beard is extracted and the gripper moves back to the first beard measurement point. The beard is now lightly clamped in the beard guide to hold the fibres in the focal plane of the microscope.
8. The microscope arm traverses across the beard and captures video images every 1.2mm across the beard.
9. The gripper pulls the beard a further 5mm and the microscope arm traverses again.
10. Steps 8 to 9 are repeated until the number of fibres seen by the computer falls below a threshold indicating the end of the beard has been reached.
11. If the number of fibres counted in the first scan of the beard has not reached the preset minimum number of fibres, the needle bed now feeds another set of fibre ends, and steps 7 to 10 are repeated.
12. When the preset fibre count has been reached, the results of each beard measurement are summed and the final results are calculated.

## OFDA4000 Software

The diameter measurement software is identical to that used in the OFDA100 except that the OFDA2000 and OFDA4000 have a 32-bit version and the maximum fibre count is extended to 300,000. The code also shares the same curvature and blob measurement algorithms as the OFDA100 and OFDA2000, and shares the same diameter profile measurement code with the OFDA2000.

To measure length, the software counts the number of fibres in each image and sums the number of fibres across each scan. The average density of fibres across each scan is also measured and used to set the correct measurement density by adjusting the needle bed feed step. This reduces operator influence and possible biases due to beard density caused by different top sizes.

A minimum number of fibres is set and measurement draws are completed until this number is reached. Currently, this is set at 4000 fibres, and the instrument takes about 5 draws at 800 fibres per draw to reach this. At this limit, the expected 95% CL for a typical top of 70mm length and 50% CVL would be

$$SD = 70 * 0.5 = 35 \text{ mm}$$

$$\begin{aligned} 95\% \text{ CL} &= 1.96 * SD / \sqrt{4000} \\ &= 1.08 \text{ mm} \end{aligned}$$

The number of fibres at each 5mm step along the beard is interpolated from the actual scan positions since the first scan is not 0mm, but at typically 6.8mm. The diameter profile at 0 mm and 5mm is set equal to the first diameter scan to simplify the analysis. The cumulative percentage of fibres at 0 and 5mm is set to 100% and the value at 10mm, 15mm etc is interpolated from the scan count above and below each point.

The hauteur distribution is calculated by multiplying the number of fibres remaining at each length by the square of the diameter at that length, which creates the cross section biased length.

At 4000 fibres measured for length, each fibre is measured many times for diameter, and the typical number of fibre measurements points for diameter is 40,000.

The parameters measured by OFDA4000 are:

1. Diameter: mean, standard deviation, comfort factor, histogram.
2. Length, hauteur, barbe, hauteur-biased barbe: mean, coefficient of variation, histogram of distribution, short fibre content of each.
3. Diameter profile along beard: graph of diameter along, standard deviation along
4. Fibre end comfort factor: measured at aligned end of beard, currently 6.8mm from end but expect to reduce to less than 5mm with next model.
5. Curvature: mean, standard deviation, histogram
6. Blob factor: same parameters as OFDA100[2]

## 7. Number of fibres in top: calculated from the length distribution

The instrument has been designed to allow for extra hardware to be added to allow measurement of medullation, dark fibre content, neps, vegetable matter and strength. The inclusion of any of these modules is not guaranteed, and industry feedback is welcome as to which of these should be investigated first.

### Experimental Results

A series of preliminary experiments was carried out as a guide to base the next phase of research. Most of the tops used in these experiments were not stored in the twisted form required to preserve the length for Almeter measurement, and it was not the aim to compare results with the Almeter in an absolute form, but as a relative indicator to the sort of differences that may be encountered in comparing length with hauteur.

#### REPEATABILITY

To test the repeatability, 10 measurements were done with the fibre limit set to a minimum of 4000. The estimated SD between measurements is calculated by

Estimated SD between samples  $SD \text{ Mean L} = (SDL) / \sqrt{4000}$

Where  $SDL = \text{meanL} * CVL / 100$

Numbers in brackets are the measured SD of the parameter.

Table1 : Length and Hauteur Repeatability

	Lot58	Lot 81	WA 6.6	WA 6.9	WA 6.43
OFDA4 Mean L	71.8(0.8)	70.6(1.1)	65.2(.6)	58.4(1.2)	80.5(1.2)
Est. SD Mean L	0.51	0.48	0.50	0.43	0.62
OFDA4 CVL	44.8(0.8)	43.2(1.2)	49.0(1.2)	46.3(1.1)	48.7(1.0)
OFDA4 H	79.2(0.6)	76.1(1.4)	64.3(1.0)	56.0(1.3)	84.6(1.6)
Est. SD Mean H	0.42	0.41	0.58	0.48	0.66

The measured SD between measurements was higher than the estimated SD. This may be due to length variability in the top. Converting the SD to CV as used in the Almeter test method [12], the average OFDA4 CV mean L is 1.42% and the average OFDA4 CV mean H is 1.68%. The Almeter test method gives the within laboratory variation CV (CV0 automatic grip) between measurements of hauteur mean at 1.80%.



**PROFILE REPEATABILITY**

Top WA6.43 measured 10 times at minimum 4000 fibres per measurement. The profile is less repeatable near the end of the beard due to the reduction in fibre count.

Figure 3: Diameter Profile, 10 Runs on top WA6.43

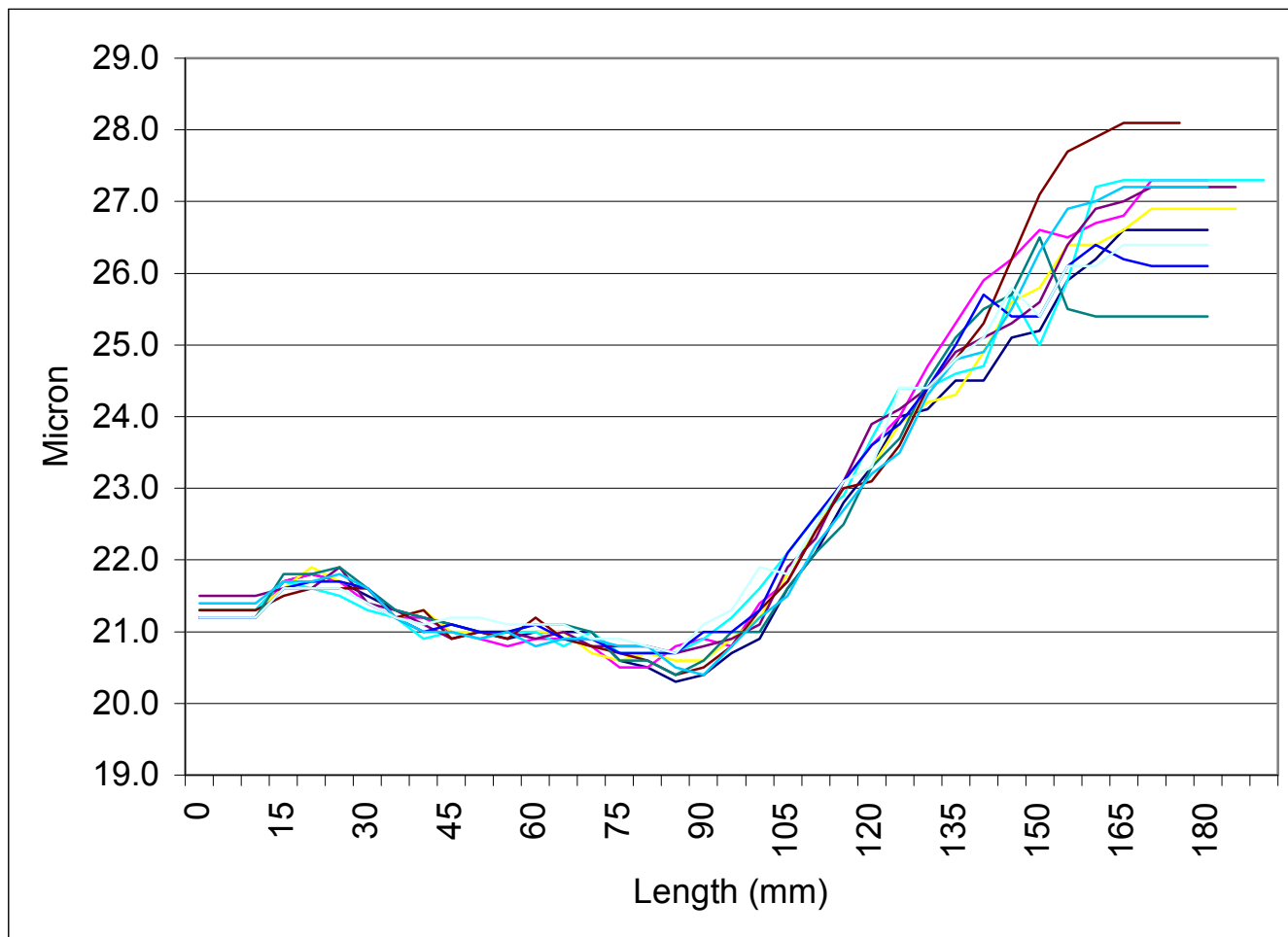

**MEAN DIAMETER REPEATABILITY**

Each top was measured 10 times, at a separation of 30mm along the top. The minimum number of fibres was set at 4000, which gave a typical number of diameter measurements in the range of 30,000 to 40,000 (each fibre is measured many times along its length). The average SD between mean diameter measurement was 0.058um, which gives a 95% confidence limit of 0.12um for a single measurement. The 95% confidence limit for 20um sliver by snippets on OFDA100 is 0.30um[4], although this includes between laboratory variance.

The 95% confidence limit for measuring the standard deviation was 0.07um. Table 2 shows the results for each top (standard deviation of the value in brackets)

Table 2: Diameter Repeatability

	A	B	C	D	E
OFDA4 Mean D	20.6(0.04)	20.7(0.04)	18.3(0.06)	15.9(0.07)	21.5(0.08)
OFDA4 SD D	4.5(0.04)	4.4(0.03)	4.7(0.04)	3.5(0.03)	5.5(0.04)

## LENGTH DIFFERENCE BY BEARD DIRECTION

It is well known with Almeter measurement that a different hauteur is obtained if the beard is extracted from the top in the same direction as it was combed when compared to extracting in the opposite direction. This is believed to be due to the formation of small hooks in some fibres, which are straightened out when the beard is extracted in one direction, but remain when the beard is extracted in the other direction.

To test the effect of direction on length and hauteur measured by OFDA4000, several tops were measured 10 times each in two directions a and b. No attempt was made to ensure that the a direction is always aligned with the top combing direction.

Table 3: Length and Hauteur by Combing Direction

Sample	OFDA4 Mean D	Almeter H*	Almeter CVH*	OFDA4 H	OFDA4 CVH	OFDA4 L	OFDA4 CVL
Lot58 a	21.5	79.5	35.6	79.7	33.1	72.6	44.0
b				75.4	35.8	70.0	44.6
Lot81 a	21.6	79.1	35.5	76.1	34.2	70.6	43.2
b				75.7	33.9	70.7	42.4
Wa6.9 a	20.5	58.1	55.1	56.0	53.8	58.4	46.3
b				58.0	52.8	59.4	46.3
Wa6.43 a	25.3	80.9	53.1	84.7	49.6	80.5	48.7
b				78.8	52.2	78.8	49.3
Wa6.6 a	19.5	63.3	59.3	64.3	57.0	65.2	49.0
b				61.5	58.5	64.8	48.9
Average	21.7	72.2	47.7	71.0	46.1	69.1	46.3

\* Almeter results were obtained up to 1 year earlier in a different laboratory and the tops were not stored in twisted form so these are presented for information only

On average the Almeter H was 1mm longer than the OFDA4000 H. This needs further quantification, but some differences will be due to the fact that the slivers had not been stored twisted before being measured on the OFDA4000. In practice it is expected that the OFDA4000 H would be slightly longer because the fibres are measured in a less relaxed state than in the Almeter. Almeter CVH was 1.6% higher than OFDA4 H .

The average difference between combing direction is 1.2mm for length and 3.1mm for hauteur and in every case, the difference in hauteur between directions is greater than the difference in length. This could only be caused by the diameter profile being different in each direction. The diameter profiles for WA6.43 which showed the biggest difference are shown here (average of 10 measurements in each direction), with 95% confidence limit error bars:

Figure 4: Diameter Profile for Top WA6.43 in Opposite Directions

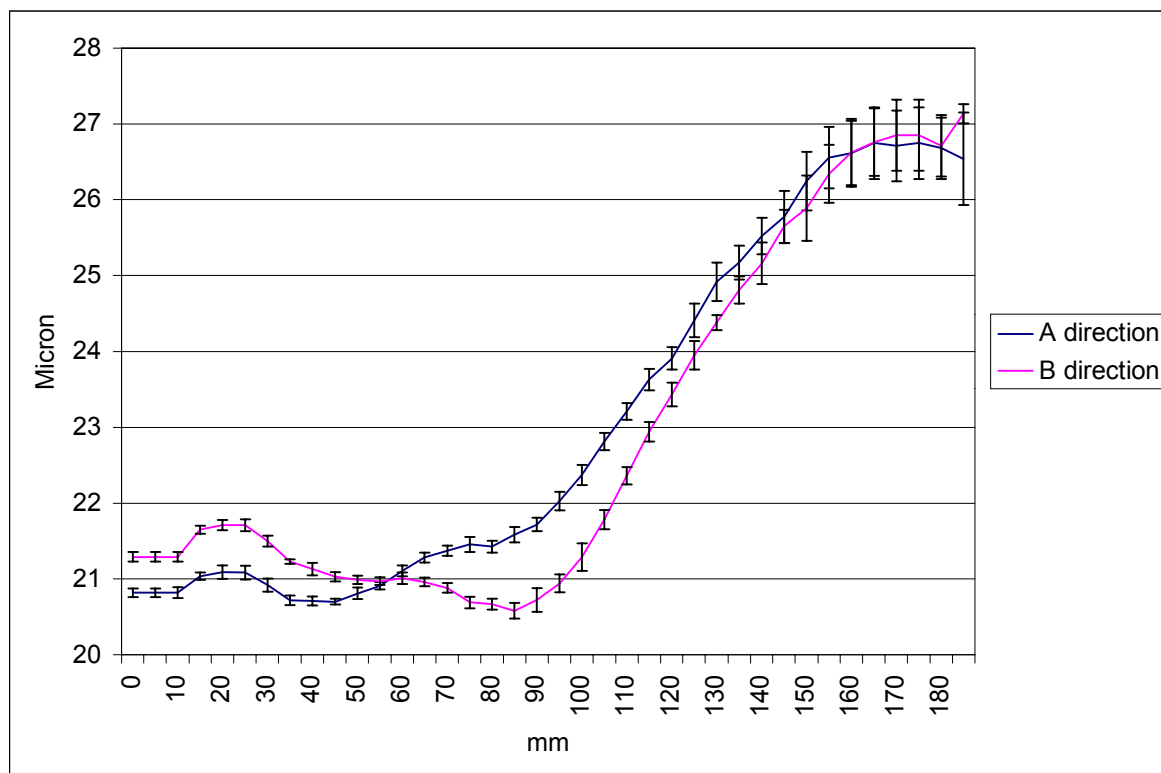

For this top, the profiles appear quite different. A possible cause is that the fibres forming hooks have a different diameter and in one direction they appear as two short fibres and in the other direction they are combed to their full length. In the above case, if the hooks were fine fibres and intact in the a direction, and were straightened in the b direction then this would give the observed profiles.

It would appear on this limited data, that the hauteur measurement has an exaggerated dependence on the combing direction due to the different profile. This is an area that needs to be further investigated, but to be careful, the recommended top preparation for one measurement on the OFDA4000 is cut a 0.5m long length of top, peel it in half down the centre and reverse one half before inserting.

## DIAMETER CALIBRATION

The 8 tops of the 13<sup>th</sup> IH Calibration series were measured, this table shows the results of two measurements of each top at the one position on the top. A minimum of 4000 fibres was set, which typically resulted in over 40,000 diameter measurements for each measurement. Almeter hauteur was measured on different top segments at a different laboratory and top samples were not stored in twisted form: provided for general information only.

Table 4: Diameter and Length of IH Calibration Tops

Assigned mean um (PM)	OFDA4 Meas Mean	Linear Fit Mean	Diff	Assigned CVD %	OFDA4 Meas CVD %	OFDA4 Length mm	OFDA4 Hauteur mm	OFDA4 CVH	AI H	AL CVH
16.66	16.58	16.73	0.07	19.98	20.48	62.4	65.1	33.0	63.7	37.5
18.31	18.23	18.39	0.08	18.21	18.41	70.7	73.1	33.2	70.0	38.0
20.38	20.16	20.34	-0.04	22.05	22.26	66.9	67.6	43.7	64.1	46.8
23.54	23.34	23.56	0.02	21.79	21.53	75.3	79.2	41.0	77.4	44.9
26.43	26.03	26.27	-0.16	21.16	20.98	81.6	82.4	49.9	80.5	53.4
30.62	30.32	30.6	-0.02	24.12	24.29	93.3	101.6	31.3	96.6	39.1
34.69	34.24	34.56	-0.13	25.32	25.21	91.7	100.6	54.5	97.1	59.2
37.69	37.53	37.88	0.19	23.26	23.47	92.0	97.6	50.1	90.8	56.6

All of the tops exhibited the typical profile of generally increasing diameter with length explaining why the hauteur is higher than the length. The profile of the top with the largest difference between hauteur and length, 34.69 is shown in Figure 5.

Figure 5: Diameter Profile of 34.69 IH Calibration Top

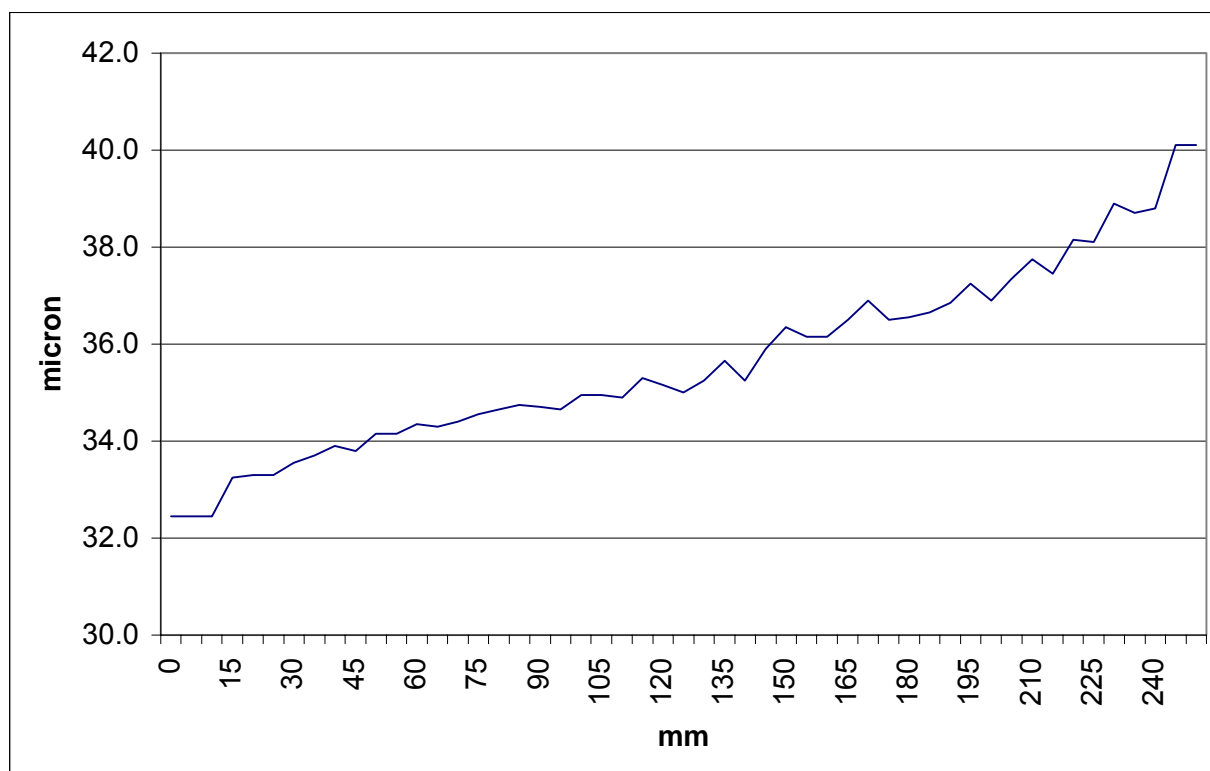

Although the diameter profile appears very large at over 7um, the effect on hauteur calculation is less since few fibres are left in the length distribution at the broad end of the profile.

### Comparison of Spring and Autumn Shorn Profiles

AGWA provided 4 tops that had been prepared from wool that had been measured by greasy staples on the OFDA2000. Two of the tops had been prepared from sheep shorn in Spring, and two tops prepared from sheep shorn in Autumn. The OFDA2000 greasy measurements were done on the first prototype and the grease factor slope had not been properly determined at that stage, the shape of the profile remains valid but this work needs to be redone on the latest OFDA2000 software if the mean diameter is to be used.

The wool was processed at CSIRO Geelong, team results were provided by Peterson from AGWA. Team 2 equation was used, without mill factor.

### **AUTUMN SHORN WOOL**

Table 5: Diameter, Length and Hauteur of Two Tops Made from Autumn Shorn Wool

	OFDA4 MeanD	OFDA4 L	OFDA4 CVL	OFDA4 H	OFDA4 CVH	Team H	Team CVH	AI H	AI CVH
lot58 top	21.4	70.5	45.2	77.2	34.5	71.0	44.0	79.5	35.6
lot81 top	21.3	70.6	41.4	76.0	32.0	70.0	43.0	79.1	35.5

These wool types show a higher short fibre content by length than by hauteur. The team prediction is closer to the length measurement than the hauteur.

Figure 6: Greasy Diameter Profile Lot58

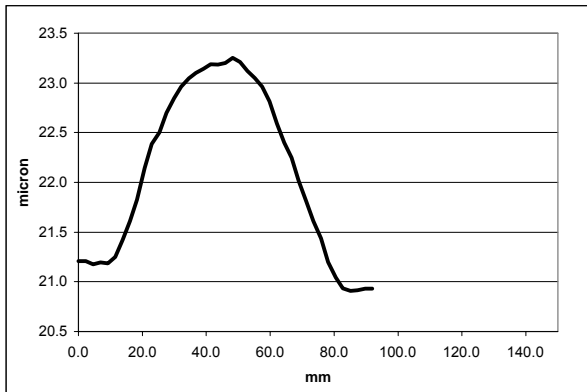

Figure 7: Top Diameter Profile Lot58

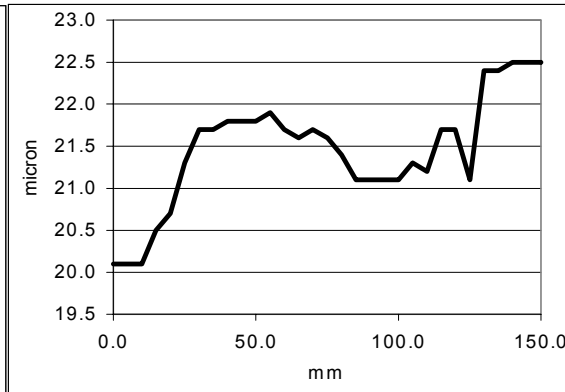

Figure 8: Length and Hauteur of Lot58 Top

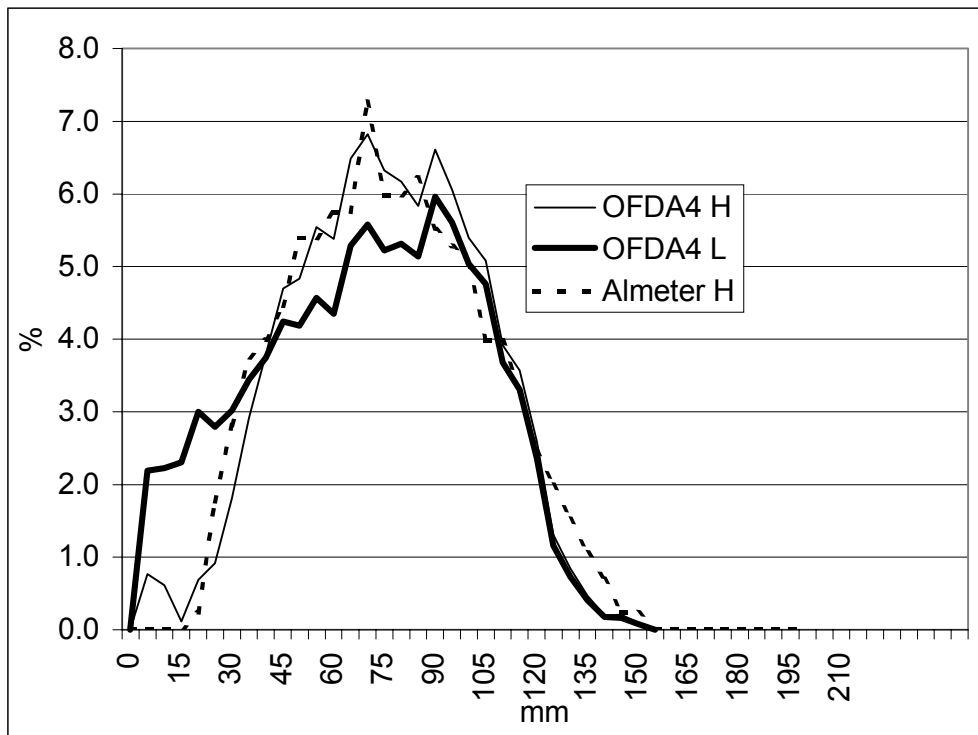

Figure 9: Greasy Diameter Profile Lot81

Figure 10: Top Diameter Profile Lot81

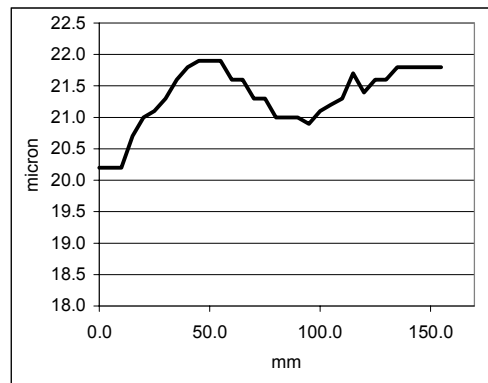
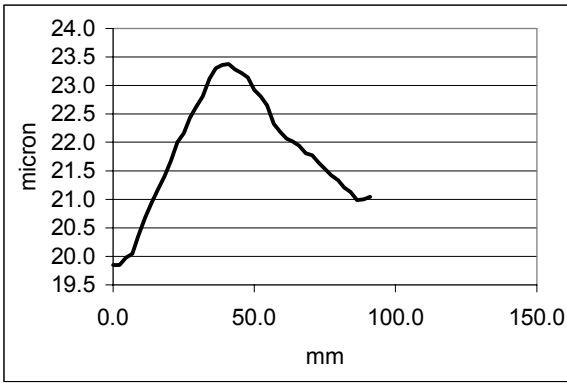
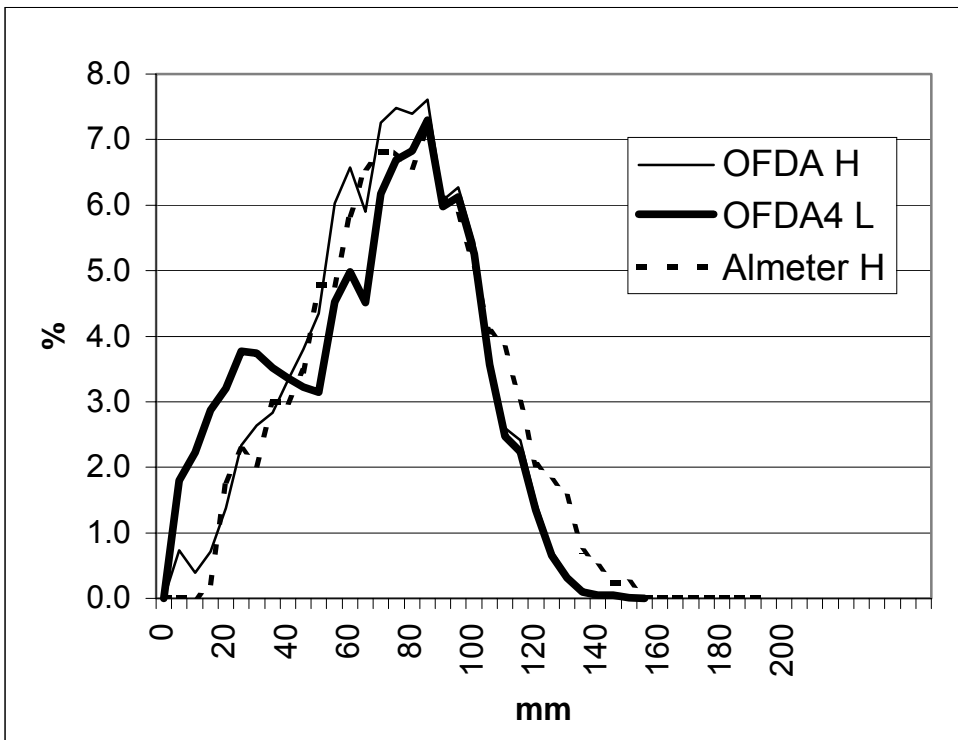

Figure 11: Length and Hauteur of Lot81 Top



**SPRING SHORN WOOL**

Table 6: Diameter, Length and Hauteur of Three Tops Made from Spring Shorn Wool

	OFDA4 MeanD	OFDA4 L	OFDA4 CVL	OFDA4 H	OFDA4 CVH	Team H	Team CVH	AI H	AI CVH
9070	21.3	74.6	46.4	73.9	50.6	69	51	73.6	50.3
9072	21.3	75.7	45.3	73.4	51.8	68	55	71.6	53.6
43	21.6	75.1	45.0	73.5	50.2	68	54	72.2	52.3

Figure 12: Greasy Diameter Profile 9072

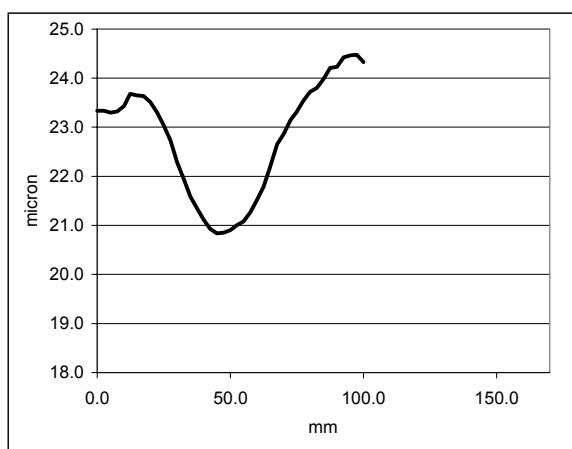

Figure 13: Top Diameter Profile 9072

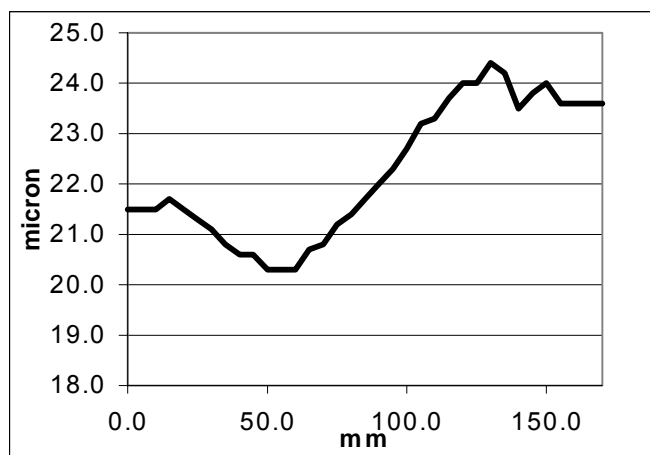

Figure 14: Length and Hauteur of 9072 Top

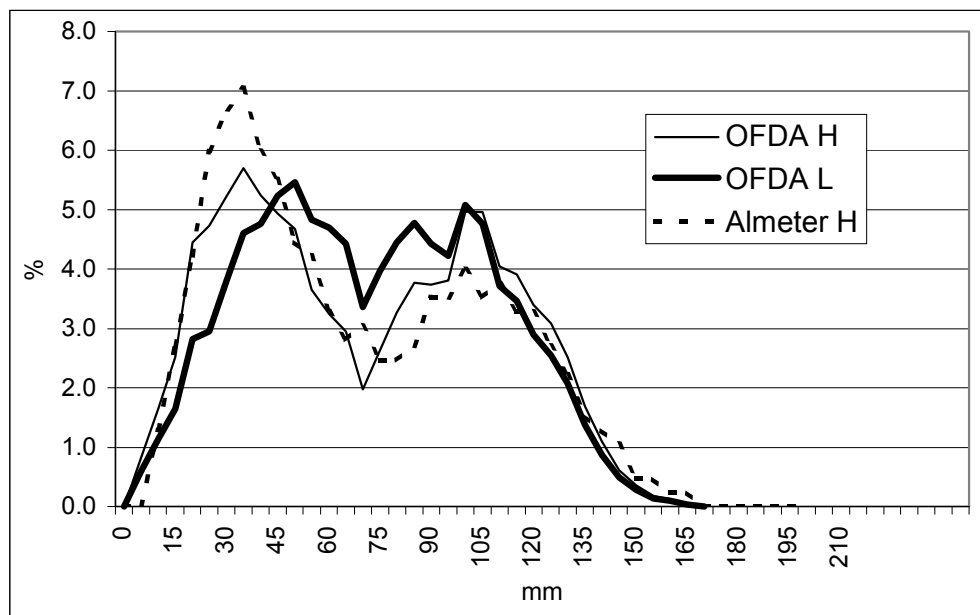



Figure 15: Greasy Diameter Profile 9070

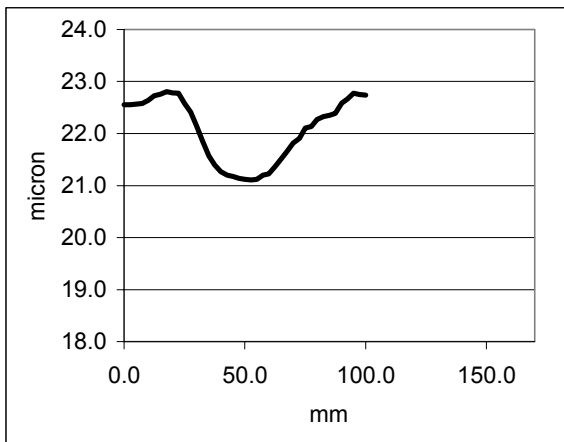

Figure 16: Top Diameter Profile 9070

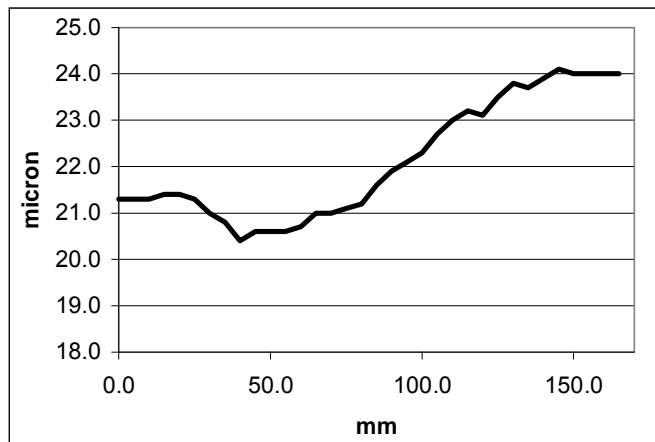
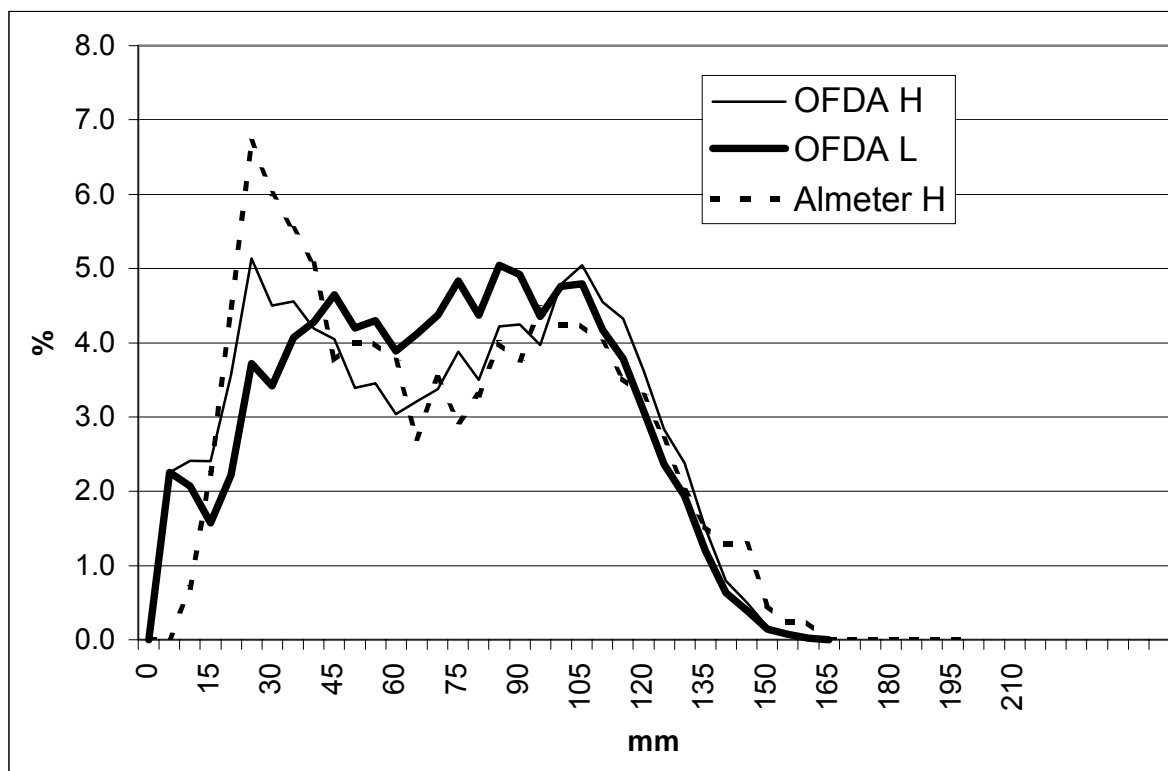

Figure 17: Length and Hauteur of 9070 Top



The Spring shorn wools show a distinct double hump by hauteur due to the diameter profile, but this hump is greatly reduced in the length distribution causing a lower OFDA4 CVL than OFDA4 CVH. The team prediction is closer to the Almeter H than it is to the OFDA4H or OFDA4L.

The different greasy profile types show a good indicator to the profile obtained in the top, and show quite different relationships between length and hauteur. The top profiles support earlier work that showed processing can be predicted from the greasy profiles [8].

The apparently longer graphs of length in the tops than in the greasy staples are due to the small percentage of longer fibres in the staples that are held in a twisted form and not seen until they are released from the staple structure.

Although mean and CV hauteur would be expected to change due to the storage of the tops, it is unlikely that the shape of the distribution would change. In all cases, there was a better match between the Almeter hauteur graph and the OFDA4 hauteur graph than with the OFDA4 length graph.

Tops with the autumn shorn profile have a much higher short fibre content than shown by the hauteur, and have a lower mean end fibre diameter which would improve the comfort factor. The spring profile length shows a less pronounced double hump than the hauteur, and the mean fibre end diameter is higher which reduces the comfort factor.

### **Conclusion**

Preliminary testing of the OFDA4000 has shown good repeatability of length, hauteur, diameter and diameter profile measurement. Contrary to earlier belief [11], significant diameter profiles were found in most tops that have been measured, including the well blended IH tops.

The OFDA4000 represents a new level of quality control for the wool top industry by providing digital video measurement of the most important characteristics, adding new measurements and doing so in a single instrument without manual involvement.

Although Almeter hauteur has been provided where available as general information, they were not performed in the same laboratory at the same time and hence no conclusions can be drawn on the relationship between Almeter hauteur and OFDA4000 hauteur.

A working group should be established to prepare a draft test method and define a set of experiments to test the OFDA4000 against existing technologies.

### References

1. Baxter, B. P., M. A. Brims and T. Taylor (1992). *Description and performance of the Optical Fibre Diameter Analyser (OFDA)*., Journal of the Textile Institute **83**(8): 507-526.
2. OFDA100 Reference Manual, BSC Electronics Pty Ltd.
3. Brims, M. and Peterson, A., *Measuring Fibre Opacity and Medullation using OFDA - Theory and Experimental Results on Mohair*, IWTO, New Delhi, Apr. 1994.
4. IWTO-47-00, *MEASUREMENT OF THE MEAN AND DISTRIBUTION OF FIBRE DIAMETER USING AN OPTICAL FIBRE DIAMETER ANALYSER (OFDA)*
5. IWTO 57-96, *DETERMINATION OF MEDULLATED FIBRE CONTENT OF WOOL AND MOHAIR SAMPLES BY OPACITY MEASUREMENTS USING AN OFDA*
6. Brims M.A., Peterson A.D. and Gherardi S.G. *Introducing The OFDA2000 – For Rapid Measurement Of Diameter Profile On Greasy Wool Staples*, IWTO Raw Wool Group, Florence, Report 4
7. [www.i-activewool.com.au](http://www.i-activewool.com.au)
8. Peterson A.D., Oldham C.M. *THE INFLUENCE OF DATE OF SHEARING ON THE PROCESSING PERFORMANCE TO TOP OF MINI-COMMERCIAL CONSIGNMENTS OF MERINO FLEECE WOOLS GROWN IN EITHER SOUTHWESTERN OR EASTERN AUSTRALIA – 2. IMPROVED PREDICTION FROM THE FD PROFILES OF STAPLES FROM COMPONENT SALE LOTS*. .10th International Wool Textile Research Conference, Aachen, Germany
9. IWTO-DTM 5-96 *METHOD OF DETERMINING WOOL FIBRE LENGTH DISTRIBUTION USING A SINGLE FIBRE LENGTH MEASURING MACHINE*
10. IWTO 16-67, *Method of Test for Wool Fibre Length using a WIRA Fibre Diagram Machine*
11. Grignet, J., *Fibre Length A New Way Forward Using Microprocessor Techniques with the AL100 and Texlab System*, Wool Science Review, 56, 1980, 81-99
12. IWTO-18-00, *Method for the Determination of Evenness of Textile Strands using Capacitance Testing Equipment*.
13. IWTO-DTM-xxx *Measurement of Fibre End Characteristics in Wool Slivers as a Guide to Fabric Skin Comfort*, Sliver Group, Nice 2001